

jungla



CATÁLOGO ENERO
2025



BLACK 14"
40020

SLATE BLUE 14"
1126801



**SMOKEY
JOE 14"**
Q850

SMOKE 14"
1126701



7154
**CARRY
COVER**

PARA SMOKEY JOE 14"
Q350



CARBÓN



KETTLE PREMIUM 22"

Q3,000

14401001



KETTLE PREMIUM 18"

SOLD OUT

441001



JUMBO JOE 18"

Q1,250

1211001



CARBÓN



PREMIUM GRILL COVER
COMPATIBLE CON CHURRASQUERAS DE CARBÓN 18"

Q325
7148



PREMIUM GRILL COVER
COMPATIBLE CON CHURRASQUERAS DE CARBÓN 22"

Q500
7150



PREMIUM GRILL COVER
COMPATIBLE CON CHURRASQUERAS DE
CARBÓN 22" CON MESA PLEGABLE

Q675
7151



PREMIUM GRILL COVER
COMPATIBLE CON PERFORMER DELUXE 22"

Q825
7152



MASTER TOUCH 22"

LA MEJOR CHURRASQUERA
DE CARBÓN.





MASTER TOUCH

GBS 22''

Q3,900

14501001



CARBÓN



AHORA CON
26 PULGADAS
DE PARRILLA
Y AHORA CON SISTEMA



* ACCESORIOS SE VENDEN
POR SEPARADO.





BLACK
1500064



MASTER TOUCH
GBS 26''
Q6,750

SMOKE
1500065



CARBÓN



7666



**DIFUSOR DE CALOR
Q1,000**

**ASADO DIRECTO
A FUEGO ALTO**
Sobre el cono

ASADO INDIRECTO
alrededor del cono

**ASADO A FUEGO
LENTO Y BAJO**
carbón al rededor del cono



CARBÓN



7433

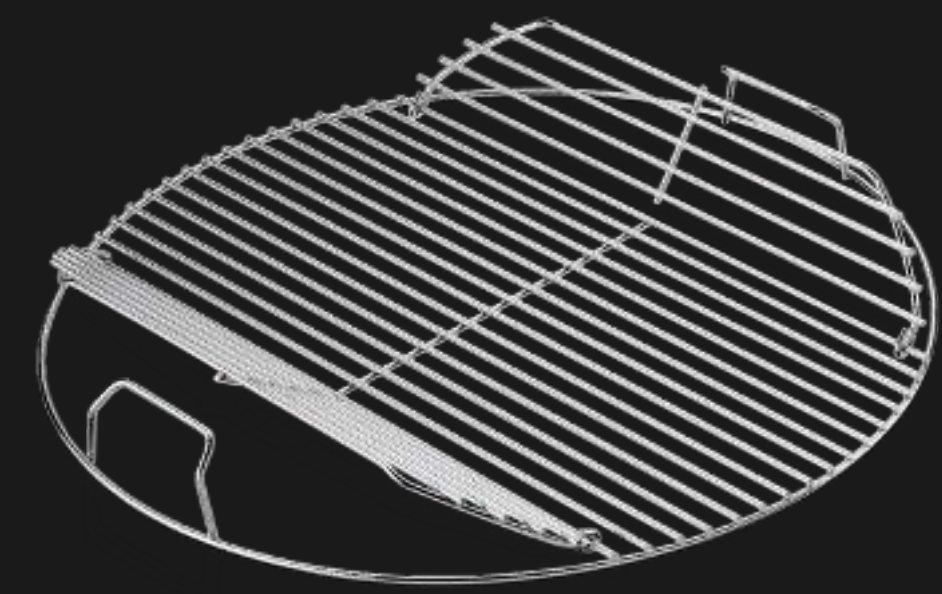

**HINGED COOKING GRATE
Q325**

Compatible con parrillas de carbón
de 18"



CARBÓN



MASTER TOUCH Gourmet BBQ System

Adapta diferentes accesorios a tu parrilla y expande las posibilidades

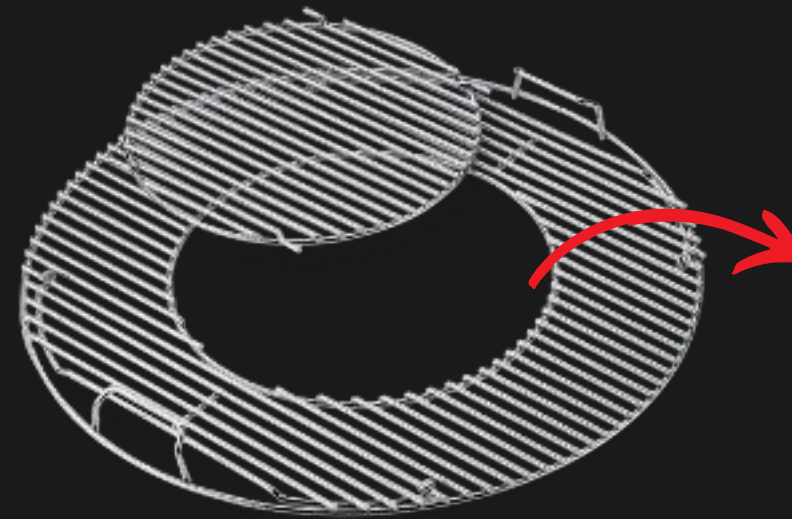

8835
PARRILLA INDIVIDUAL
GOURMET BBQ SYSTEM COOKING GRATE
22" de diámetro de parrilla

Q500

Sistema de parrilla ya incluido en Weber Master Touch 22", Performer Black, Performer Dlx y Summit Kamado

GBS - 8838 | Poultry Roaster
Q650



GBS - 8834 | Sear Grate
Q600



GBS - 7425 | Wok

SOLD OUT



GBS - 7421 | Griddle

SOLD OUT



GBS - 8836 | Pizza Stone
Q675





PERFORMER BLACK
Q4,750
15301001

PERFORMER DELUXE
Q7,000
15501001



CARBÓN



SUMMIT KAMADO

PARRILLA Y AHUMADOR DE
CARBÓN DE 24" PULGADAS

Q16,000

18201001



CARBÓN

jungla

SMOKEY MOUNTAIN

Ahumador de carbón
de dos niveles con parrilla de
carbón y bowl para líquidos



weber 



Smokey Mountain

Ahumador de carbón de dos niveles con parrilla de carbón y bowl para líquidos





Smokey Mountain 22"

Q6,500

731001



Smokey Mountain 18"

Q5,750

721001



Smokey Mountain 14"

Q3,500

711001



CARBÓN



CHUNKS PARA AHUMAR:
MESQUITE - HICKORY - PECAN - CHERRY - APPLE



CHIPS DE MADERA
PRECIO Q50.00

CHUNKS DE MADERA
PRECIO Q75.00

CORTA LEÑA EN UN PAR DE GOLPES!



KINDLING CRACKER[®]





CORTA TU LEÑA EN UN
PAR DE GOLPES!



Cortador de leña
de hierro fundido y martillo

Q850

Regular Q1,100

jungla

NEW

Searwood

GRILL - AHUMADOR ELÉCTRICO
DE PELLETS





NEW

Searwood

- Rango de temperatura completo de 180° a 600°F para ahumar y asar.
- La cocción **DirectFlame™** crea un efecto dorado, crujiente y sellado.
- La zona para sellar ahora es en toda la parrilla y te permite colocar más comida en la flama.
- **Rapid React™** PID se calienta rápidamente y recupera la temperatura cuando se tapa y se abre.
- La configuración **SmokeBoost™** intensifica el sabor ahumado.
- Cocina con confianza con controles digitales intuitivos en la parrilla y conectividad WIFI y Bluetooth que te permite monitorear y controlar la parrilla de forma remota, ver gráficos en vivo de la cocción, recibes alertas de preparación, recetas y más desde la aplicación WEBER CONNECT desde tu celular o tablet.



ASA EN CADA PULGADA

La sear zone de la rejilla completa se calienta de manera unisma y al máximo de cada centímetro de la parrilla, por lo que obtienes más comida en la llama.



COMIDA QUE LUCE BIEN PERO SABE MEJOR

La cocción DirectFlame™ crea un gran sabor y acabado dorado y crujiente. Sin un gran difusor de láminas que bloqueen la llama, la comida se ve tan bien como sabe con marcas de sellado profundas, dorado y corteza crujiente.



AUMENTA EL SABOR AHUMADO

El ajuste SmokeBoost™ mantiene la temperatura a 180 °F, optimizando la absorción de humo en los alimentos e intensificando el sabor.



SEARWOOD™ 600 PELLET GRILL

Q13,750

1500120



Pellet



SEARWOOD™ XL 600 PELLETT GRILL

Q16,500

1500121

NEW



Pellet



weber | Premium Grill Cover

Compatible with Searwood 600 pellet

SOLD OUT

3400145



weber | Premium Grill Cover

Compatible with Searwood XL 600 pellet

Q1,250

3400146





SABORES DE PELLETS

GRILLMASTER BLEND - CHERRY - MESTIQUE - HICKORY



BOLSA DE 20 LBS
PRECIO Q250.00

jungla

LUMIN
ASADOR ELÉCTRICO





CORTE SELLADO SIN LLAMA!

Deja tu corte como de restaurante gracias al rango de temperatura que alcanza hasta los 600 grados!



MÁS QUE UNA CHURRASQUERA!

Puedes cocinar al vapor una guarnición de vegetales e incluso descongelar alimentos con la configuración de vapor exclusiva de Lumin.



AGREGA UN TOQUE DE HUMO!

Con Weber Lumin y la nueva configuración de infusión de humo podrás dejar un toque ahumado en tus cortes, quesos o vegetales.



UN BUFFET EN TU TERRAZA!

Mantén la comida caliente para que tus invitados puedan servirse solos! Weber Lumin posee la opción para mantener caliente tus alimentos.



DE CONGELADO A MARCAS DE PARRILLA

Omite un paso! Con Weber descongelando durante el precalentamiento de la parrilla. Cualquier cosa, desde camarones congelados, nuggets de pollo o incluso mini pizzas.



weber
LUMIN
Q6,500



Eléctrico



92400901



92010901



91010901



91280901

weber
LUMIN
COMPACT

Q5,750



91400901



Eléctrico





LUMIN
STAND MEDIUM

Q2,000

CÓDIGO
6619



LUMIN
STAND SMALL

Q1,750

CÓDIGO
6618

BANDEJAS
PARA SERVIR
CALIENTE



COCINA A VAPOR
O AGREGA CHIPS
DE MADERA

REJILLA PARA
VEGETALES Y/O
AHUMADOR

KIT VERSÁTIL MEDIANO

Q1,000

CÓDIGO
6614

BANDEJAS
PARA SERVIR
CALIENTE



COCINA A VAPOR
O AGREGA CHIPS
DE MADERA

REJILLA PARA
VEGETALES Y/O
AHUMADOR

KIT VERSÁTIL PEQUEÑO

SOLD OUT

CÓDIGO
6613



GRIDDLE MEDIUM
LUMIN

Q1,250

CÓDIGO
6612

GRIDDLE SMALL
LUMIN

Q1,000

CÓDIGO
6611



jungla



MASTERBUILT



QUICKSTART™ AUTO-IGNITION

ELIMINA LA MOLESTIA DE ENCENDER MANUALMENTE EL CARBÓN Y ENCIENDE TU PARRILLA CON SOLO PULSAR UN BOTÓN USANDO EL ENCENDIDO AUTOMÁTICO QUICKSTART™.

¡OBTÉN LA COMODIDAD DE LA PARRILLA DE GAS CON EL SABOR DEL CARBÓN!



MASTERBUILT WIFI

CONTROLA TU PARRILLA DESDE CUALQUIER LUGAR USANDO LA TECNOLOGÍA WIFI DE MASTERBUILT Y SU APP PARA ESTABLECER Y CONTROLAR LA TEMPERATURA, DESCUBRE NUEVAS RECETAS Y MÁS.



PLACA DE HIERRO FUNDIDO QUICKSEAR™

¡VERSÁTIL Y DE LIMPIEZA RÁPIDA!
CON ELLA PODRÁS DORAR O SALTEAR TUS ALIMENTOS PREFERIDOS DE FORMA PRÁCTICA Y DELICIOSA.



CHARCOAL MINIHOPPER™

ESTE ALMACENAMIENTO INTERNO PUEDE CONTENER HASTA 5 LIBRAS DE CARBÓN O 7 LIBRAS DE BRIQUETAS, ¡GARANTIZANDO HASTA 8 HORAS DE USO CONTINUO!



MASTERBUILT



MASTERBUILT AUTOIGNITE SERIES 545

PARRILLA ELÉCTRICA

Q6,250.00

MB20041124



Eléctrico
y carbón



MASTERBUILT



NEW

MASTERBUILT GRAVITY SERIES 600

CHURRASQUERA Y AHUMADOR ELÉCTRICO

Q9,000
MB20041023



Eléctrico
y carbón



ESTANTES FOLDAWAY™

LOS ESTANTES PLEGABLES PROPORCIONAN ESPACIO ADICIONAL PARA COCINAR, MIENTRAS QUE EL ESTANTE FRONTAL DE ACERO INOXIDABLE PROPORCIONA ESPACIO ADICIONAL PARA LA PREPARACIÓN.



VERSATILIDAD AHUMAR + DORAR

ALCANZA 370°C EN 14 MINUTOS, 230°C EN 10 MINUTOS Y 110°C EN 8 MINUTOS. INCLUYE UN INSERTO DE PLANCHA, PARRILLAS DE COCCIÓN REVERSIBLES DE HIERRO FUNDIDO PARA AHUMAR Y DORAR Y UNA REJILLA DE CALENTAMIENTO O PARA AHUMAR



DIGITALFAN CONTROL

DIGITALFAN™ PARA UN CONTROL PRECISO DE LA TEMPERATURA. CON SOLO PRESIONAR UN BOTÓN, EL VENTILADOR CONTROLADO DIGITALMENTE MUEVE EL FLUJO DE AIRE DESDE LA TOLVA DE CARBÓN A LA CÁMARA DE COCCIÓN Y MANTIENE LA TEMPERATURA DE COCCIÓN DESEADA.



MASTERBUILT



MASTERBUILT GRAVITY SERIES 800

CHURRASQUERA, PLANCHA Y AHUMADOR ELÉCTRICO

SOLD OUT

MB20040221



Eléctrico
y carbón

MASTERBUILT



MASTERBUILT PIZZA OVEN

SOLD OUT

MB20181722



MASTERBUILT™

24"



COVER FOR GRAVITY SERIES 545

SOLD OUT

MB20080220

COVER FOR GRAVITY SERIES 800

Q1,000

MB20080221



MASTERBUILT WIFI

CONTROLA TU PARRILLA DESDE CUALQUIER LUGAR USANDO LA TECNOLOGÍA WIFI DE MASTERBUILT Y SU APP PARA ESTABLECER Y CONTROLAR LA TEMPERATURA, DESCUBRE NUEVAS RECETAS Y MÁS.

VERSATILIDAD AHUMAR + SELLAR

INCLUYE REJILLAS DE HIERRO FUNDIDO REVERSIBLES PARA AHUMAR + SELLAR A UN AHUMADO BAJO Y LENTO O PARA SELLAR A ALTA TEMPERATURA

DIGITALFAN CONTROL

DIGITALFAN™ PARA UN CONTROL PRECISO DE LA TEMPERATURA. CON SOLO PRESIONAR UN BOTÓN, EL VENTILADOR CONTROLADO DIGITALMENTE MUEVE EL FLUJO DE AIRE DESDE LA TOLVA DE CARBÓN A LA CÁMARA DE COCCIÓN Y MANTIENE LA TEMPERATURA DE COCCIÓN DESEADA.



MASTERBUILT



MASTERBUILT GRAVITY SERIES 1050

PARRILLA Y AHUMADOR ELÉCTRICO

Q12,000
MB20041220



Eléctrico
y carbón



MASTERBUILT



NEW

MASTERBUILT GRAVITY SERIES XT

PARRILLA Y AHUMADOR

Q20,000
MB20041223



Eléctrico
y carbón



MASTERBUILT

**PORTABLE CHARCOAL
GRILL WITH CART**

Q4,500
MB20040722



MASTERBUILT

**PORTABLE CHARCOAL
GRILL**

Q3,000
MB20040522





MASTERBUILT



MASTERBUILT
FIRE STARTERS

CAJA DE 48 INICIADORES

Q150
MB20091521



MASTERBUILT

LUMP CHARCOAL
16LBS.

Q225
MB20091621





 **KAMADOJOE**

GRILL . AHUMADOR . HORNO
DE CERÁMICA



 **KAMADOJOE**

13.5"



KAMADO JOE JR BUNDLE

SOLD OUT
KJ13RH



Carbón



PREMIUM GRILL COVER

COBERTOR PARA KAMADO JR

Q750
KJ15080420



SOAPSTONE FOR JOE JR

IDEAL PARA UNA VARIEDAD DE ALIMENTOS, INCLUIDOS PESCADO, CARNES Y VERDURAS, LA SUPERFICIE DE COCCIÓN DE ESTEATITA ES ANTIBACTERIANA Y RESISTENTE A LAS MANCHAS.

Q1,250
KJ15090720



JOE JR CART WITH SHELVES

SOLD OUT

KJ15112524



 **KAMADOJOE**

18"



CLASSIC JOE™ GRILL - SERIES II

Q16,250.00
KJ23RHC



Carbón



 **KAMADOJOE**

18"



**CLASSIC JOE™ GRILL - SERIES III
STAND ALONE**

**Q20,000.00
KJ15040721**



Carbón



 **KAMADOJOE**

18"



CLASSIC JOE™ GRILL - SERIES III

Q25,000.00
KJ-15040921



Carbón



 **KAMADOJOE**

18"



GRILL COVER FOR CLASSIC JOE

Q1,250.00
KJ-GC23BWFS



 **KAMADOJOE**



Eléctrico
y carbón



KONNECTED JOE 18"

SOLD OUT
KJ15041123

> CONOCE MÁS



BOTÓN AFS

ELIMINA LA NECESIDAD DE ENCENDER MANUALMENTE EL CARBÓN CON UN ELEMENTO INCORPORADO PARA ENCENDER UNA LLAMA RÁPIDAMENTE



TABLERO DE CONTROL DIGITAL

PRESENTA GRÁFICOS DE TEMPERATURA LAS 24 HORAS, ALERTAS DE NOTIFICACIÓN Y CONTROL AUTOMÁTICO DE TEMPERATURA PARA COCINAR CON PRECISIÓN



CONECTIVIDAD DE APLICACIONES

ESTABLECE Y AJUSTA LA TEMPERATURA Y TIEMPO, CONTROLA LAS SONDAS DE CARNE E INSPÍRATE CON NUEVAS RECETAS EN LA OPCIÓN DE BÚSQUEDA DE RECETAS.

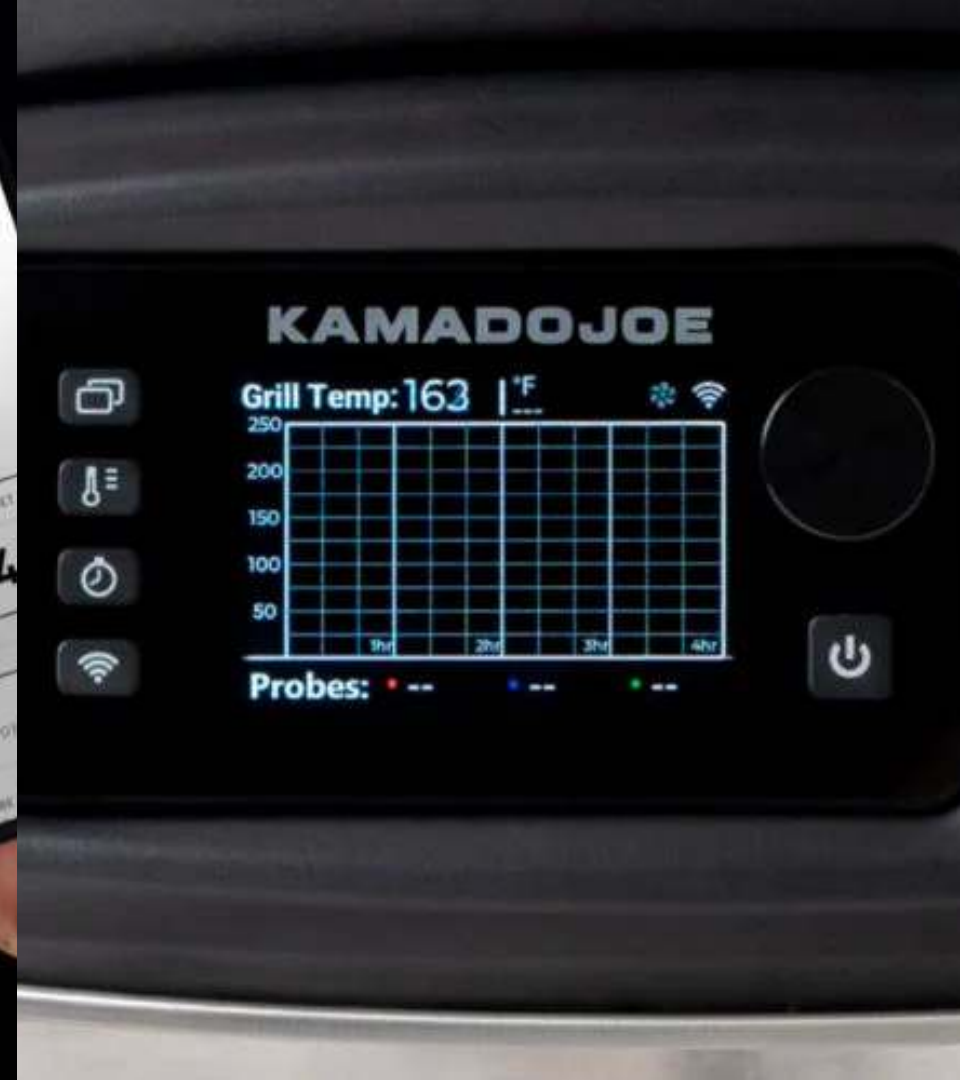

GRÁFICOS DE TEMPERATURA

SUPERVISA LA TEMPERATURA DEL CORTE A LO LARGO DE LA COCCIÓN CON EL GRÁFICO DE TEMPERATURA DE ÚLTIMA GENERACIÓN PARA CONVERTIRTE EN UN MAESTRO DEL ARTE CULINARIO.



KONNECTED JOE COMO FUNCIONA



KONTROL™ BOARD

TEMPORIZA Y MONITOREA TU
ASADO/AHUMADO

PASO 1
ENCIENDE TU KAMADO

PASO 2
SELECCIONA UN MODO
DE COCCIÓN

PASO 3
TEMPORIZA LA TEMPERATURA

PASO 4
MONITOREA LA COCCIÓN

ENCENDIDO AUTOMÁTICO AFS

ENCIENDE EL CARBÓN
RÁPIDO CON TAN SOLO
OPRIMIR UN BOTÓN.

DIGITAL FAN

MANTIENE LA TEMPERATURA
Y CONTROLA EL FLUJO DE
AIRE.



 **KAMADOJOE**

24"



BIG JOE™ GRILL - SERIES II

Q2 SOLD OUT .00
BJ24RHC



Carbón



 **KAMADOJOE**

24"



BIG JOE™ GRILL - SERIES III

Q37,750.00

KJ-15041021



Carbón



 **KAMADOJOE**

24"



GRILL COVER FOR BIG JOE

Q1,500.00
BJ-GC24BWFS

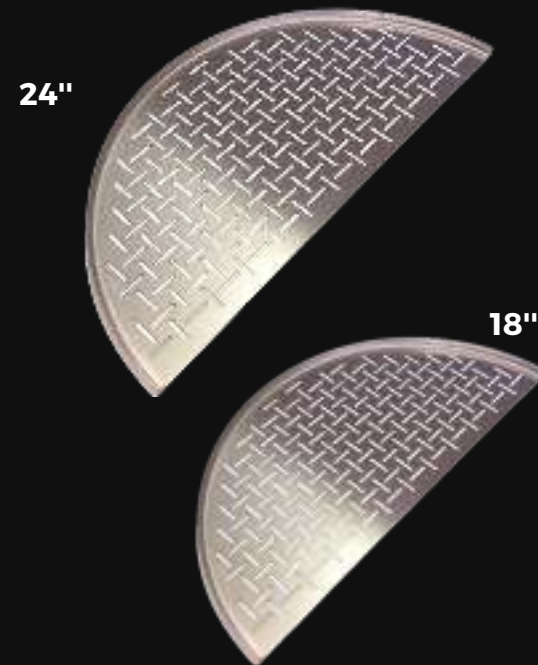

Half Moon SS

Media luna de acero inoxidable para cocción de vegetales y mariscos

Classic Joe II 18" - **Q1,250**

Big Joe II 24" - **Q1,750**



Chicken Stand

Q250

KJ-CS

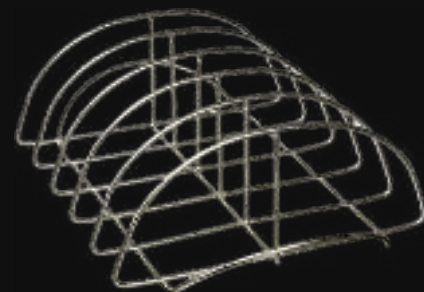

Rib Rack

Soporte para costillas, espacio para 5 racks

SOLD OUT

KJ-RR



Kamado Joe BIG BLOCK - XL Lump Charcoal - 20 lbs

Rinde hasta 16 horas

Q500

KJCHAR



Kamado Joe - Chunks -10 lbs

Hickory
Apple
Maple
Pecan

Q250

KJ-WCHUNKS



Kamado Joe - Fire Starters

Caja de 24 iniciadores

Q175

KJ-FS



24"

18"

Ideal para una variedad de alimentos, incluidos pescado, carnes y verduras, la superficie de cocción de esteatita es antibacteriana y resistente a las manchas, por lo que nunca tendrá que preocuparse por la contaminación cruzada o la limpieza desordenada.

La gruesa losa de esteatita canadiense distribuye el calor de manera uniforme y mantiene los jugos dentro de la carne para una comida llena de sabor.

La superficie de esteatita también inhibe los brotes, lo que significa menos carne quemada y mayor seguridad

SOAPSTONE

18" - Q1,500

24" - Q2,000

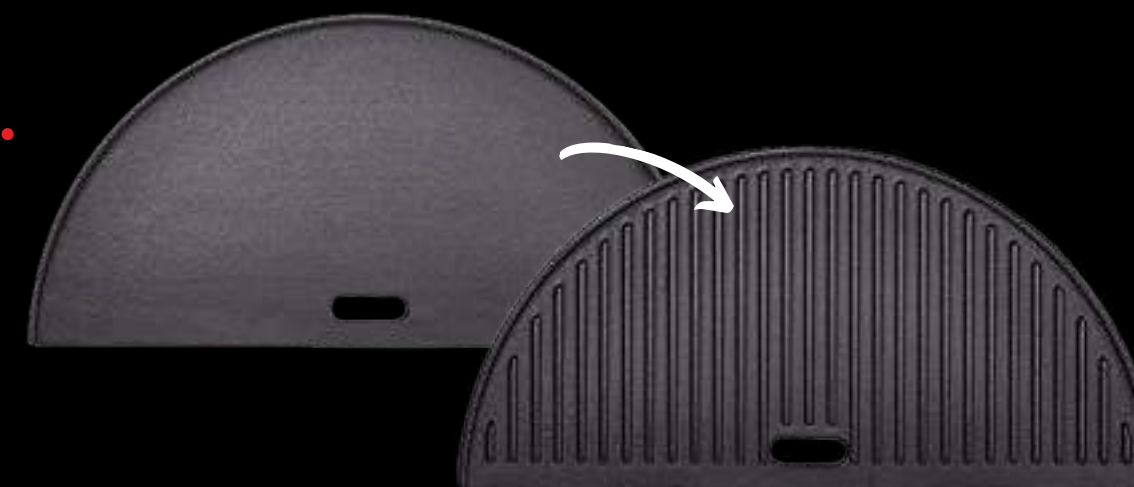

Plancha de dos caras ofrece una superficie lisa y una superficie acanalada, perfecta para todas las cocciones de hierro fundido. Mezcle y combine diferentes superficies para adaptarse a cualquier necesidad y estilo.

La plancha de doble cara ofrece una superficie lisa y una superficie acanalada El hierro fundido ofrece una excelente retención de calor y es muy resistente. Para usar con el sistema de cocción flexible Divide & Conquer Disponible para los modelos Classic y Big Joe

REVERSIBLE GRILL & GRIDDLE

Classic Joe II 18" - Q1,000

Big Joe II 24" - Q1,250



24"



18"

El hierro fundido es ideal para todos los cortes, y las abundantes marcas de rejilla doran las carnes y sellan el sabor. Mezcle y combine diferentes superficies para adaptarse a cualquier necesidad y estilo.

CAST IRON HALF MOON GRATE

Classic Joe II 18" - Q775

Big Joe II 24" - Q900



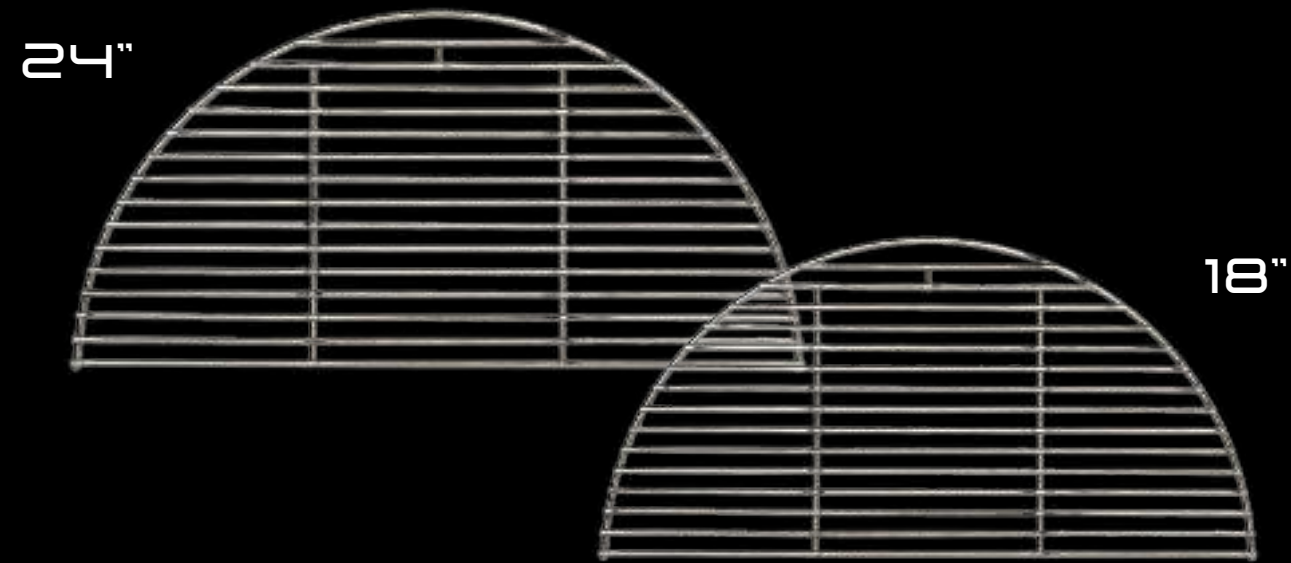

El hierro fundido es ideal para todos los cortes, y las abundantes marcas de rejilla doran las carnes y sellan el sabor. Mezcle y combine diferentes superficies para adaptarse a cualquier necesidad y estilo.

HALF-MOON STAINLESS STEEL COOKING GRATE

Classic Joe II 18" - Q475

Big Joe II 24" - Q600





Resistente e innovadora superficie de cocción de acero inoxidable que evita que se pegue a los alimentos, lo que facilita mantener intactos los filetes de pescado enteros, y las ranuras tienen un tamaño específico para evitar que las verduras se caigan. La superficie proporciona una distribución uniforme del calor, mientras que las ranuras crean marcas de parrilla perfectas para el enchapado.

REJILLA DE ACERO INOXIDABLE PARA PESCADO Y VERDURAS

Classic Joe II 18" - Q1,250

Big Joe II 24" - Q1,750



19.75"



15"

El deflector de calor Kamado Joe de cerámica le permite crear zonas de calor en su parrilla kamado, que bloquea parcialmente el calor para proporcionar una llama abierta e indirecta. Mezcle y combine diferentes superficies para adaptarse a cualquier necesidad y estilo.

PLACA DEFLECTORA DE MEDIA LUNA
(JUEGO DE 2)

Classic Joe II 15" - Q725

Big Joe II 19.75" - Q975



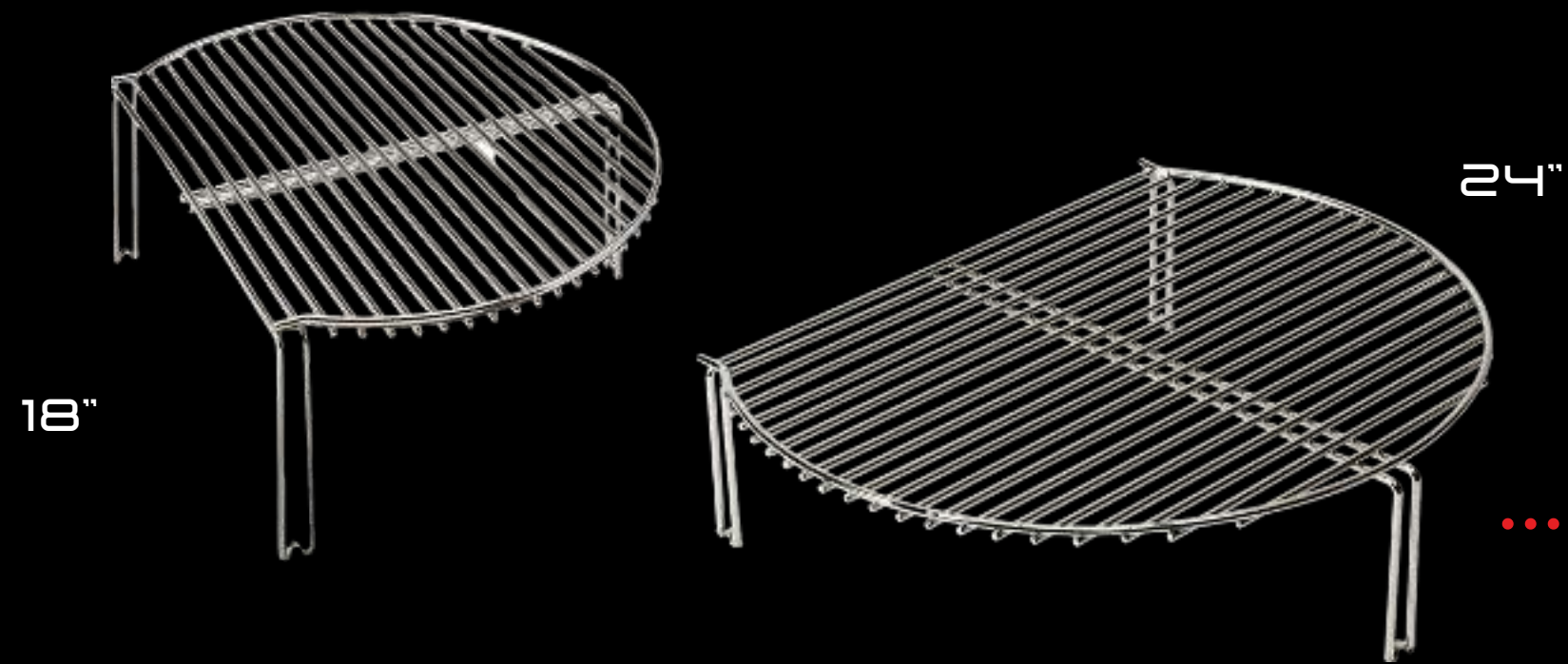

Sentado directamente sobre la rejilla de la parrilla con un generoso espacio libre de cuatro pulgadas. Consigue diferentes niveles de temperatura en una misma cocción

GRILL EXPANDER

Classic Joe II 18" - Q1,000

Big Joe II 24" - Q1,750



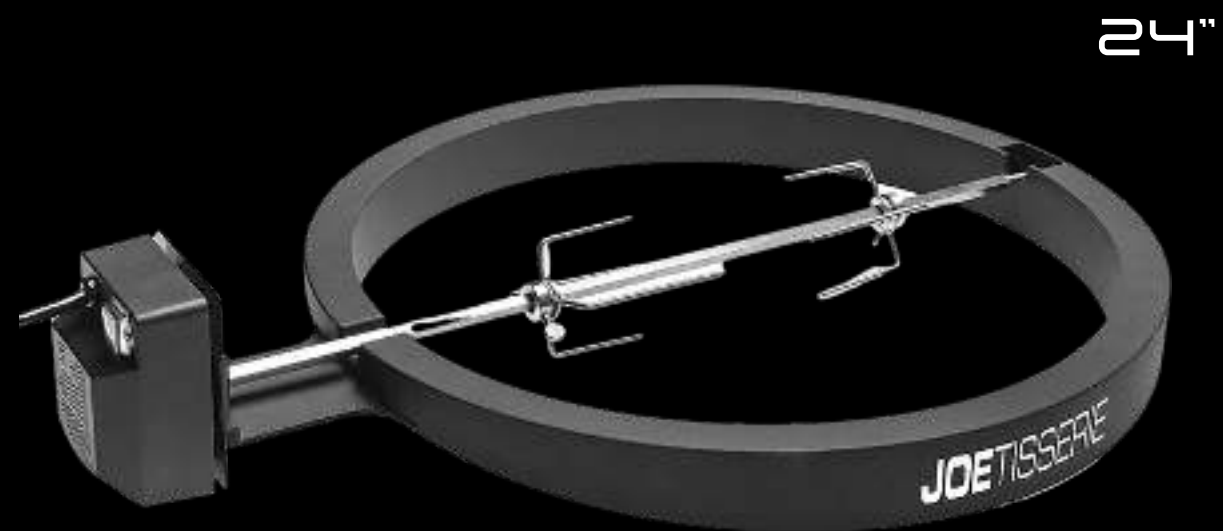

Ajustables para un equilibrio perfecto y una rotación constante. Gire hasta 50 libras de carne de res, cerdo o pollo con un potente y silencioso motor de 120V. El kit de asador es fácil de instalar

JOETISSERIE

Classic Joe II 18" - Q3,750

Big Joe II 24" - Q4,500





 **KAMADOJOE**



Una de las últimas innovaciones, el duradero aluminio fundido DōJoe transforma su Kamado Joe en el mejor horno para pizza de su clase. Ideal para principiantes y chefs expertos por igual, la forma de cuña distintiva del DōJoe hace que mantener temperaturas constantes que oscilen entre 400 ° F y 700 ° F sin esfuerzo

DŌJOE

Classic Joe II 18" - **SOLD OUT**

Big Joe II 24" - **SOLD OUT**



Con un borde plano de madera diseñado para deslizarse debajo de la base de la pizza para un chapado sin esfuerzo, el Kamado Joe Pizza Peel es la herramienta ligera perfecta para servir.

PIZZA PEEL

Q250

KJ-PP

 KAMADOJOE



Kamado Joe Deep Dish pizza te permite servir con calidad de pizzería, así como paella, guisos y pan.

DEEP DISH PIZZA

Q600

KJ-DDPS



Hecha de cerámica resistente, esta piedra para pizza está hecha para durar y también es fácil de limpiar.

CERAMIC PIZZA STONE

Classic Joe II 18" - Q1,000

Big Joe II 24" - Q1,250

KJ-PS23/24



Cocina guarniciones, postres, mariscos, salsas y un sin fin de opciones en tu churrasquera con el Wok de Kamado Joe.

HARBON STEEL WOK

Q1,750

KJ15124922

 **KAMADOJOE**



Excelente retención de calor y durabilidad, el hierro fundido es ideal para dorar y sellar.

SEAR PLATE

Q725

KJ15090620

 **KAMADOJOE**

GAS PORTÁTILES

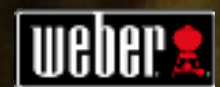



Gas

weber TRAVELER

Q5,000

9010001



Funciona con
cilindro desechable
de 1 lb o consulta por
el adaptador
a gas de 20 lbs

Perfecta para viajes!



Compacta y portátil



7031



WEBER TRAVELER
Reversible Prep & Serve
Q425



7030

WEBER TRAVELER
Cargo Protector
SOLD OUT





Gas

14.5"



Interior



| Go Anywhere Gas

Q825

121020

Utiliza cilindro de gas de 1 lb





51010001

weber | **Q Series 1200**

Churrasquera de gas portátil,
utiliza cilindro de gas desechable

Q3,000



Gas



54060001

weber | **Q Series 2200**

Churrasquera de gas portátil,
utiliza cilindro de gas desechable

SOLO OUT

*Carrito se vende por separado
+Q1,250

*Cover se vende por separado
+Q250



Gas



57060001

weber | **Q Series 3200**

Churrasquera de gas estacionaria.
Carrito viene incluido. Dos quemadores
y mayor espacio de parrilla.

SOLO OUT



Gas



weber | **Portable Cart**

Carrito portátil para
Q-1200 y Q-2200

Q1,250

6557



weber | **Patio Cart**

Carrito portátil para Q-2200

Q2,000

6525



weber | **Plancha para Q1000
Q500**

weber | **Plancha para Q2000
Q700**

weber | **Plancha para Q3200
Q750**



weber | **Manguera Adaptadora**

Para usar las churrasqueras:
Q-1200, Q-2200, Traveler

Q400

6501

jungla



Alimenta tu
Quriosidad

jungla

Alimenta tu
Quriosidad

Conoce la nueva
Q Series 2800

Tapa de domo alto: Admite alimentos más grandes como pollos enteros.

El amplio rango de temperatura de 250° - 700°F brinda más formas de asar.

Bandeja extraíble mejorada

El quemador adicional (+) te permite alcanzar y mantener temperaturas extra altas o bajas





Q 2800N+ GAS GRILL

2 QUEMADORES

Q5,750

1500375/7

Hasta 18
cuotas sin
recargo



Gas



NEW

weber | Inserto Plancha

Compatible con
Q 2800N+

Q2,000

3400248

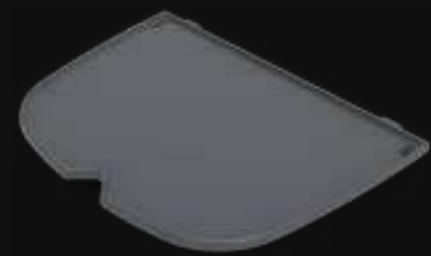

NEW

weber | Inserto Media Plancha

Compatible con
Q 2800N+

Q1,000

3400247



NEW

weber | Compact Stand

Compatible con Series Q

SOLD OUT

3400262



NEW

weber | Portable Cart

Compatible con Series Q

Q1,900

3400263



NEW



weber | **Cover for Q 2800N+**
Q450
3400232

NEW



weber | **Cover for Q 2800N+**
Compatible con Q 2800N+ con carrito
Q1,000
3400233

jungla

NEW



PLANCHAS

SLATE



COCINA SIN PUNTOS CALIENTES O FRÍOS

EL CALOR UNIFORME DE BORDE A BORDE TE PERMITE COCINAR ALIMENTOS DE MANERA CONSISTENTE, SIN PUNTOS FRÍOS O CALIENTES, SIN IMPORTAR DÓNDE LOS COLOQUES EN EL ÁREA DE COCCIÓN.



LISTA PARA USAR NADA MÁS AL SACARLA DE LA CAJA

EL ÁREA DE COCCIÓN DE PORCELANA ESMALTADA RESISTENTE A LAS ADHERENCIAS FACILITA EL GIRAR Y DESLIZAR LOS ALIMENTOS POR LA PLANCHA MIENTRAS COCINAS.



MANTÉN A LA MANO TUS ACCESORIOS PARA LA PLANCHA

EL SISTEMA DE PREPARACIÓN, COCCIÓN Y ALMACENAMIENTO WEBER WORKS FACILITA EL TRANSPORTE Y LA ORGANIZACIÓN DE TODO LO QUE NECESITAS, PARA QUE COCINAR A LA PLANCHA SEA MÁS CÓMODO Y DIVERTIDO.



SLATE RUST-RESISTANT 30"

Q9,975

1500014



Mueble abierto



Gas



SLATE RUST-RESISTANT 30" CON TERMÓMETRO DIGITAL

Q11,000
1500215



Termómetro digital

Espacio de
almacenamiento



Gas



SLATE RUST-RESISTANT 30" CON MESA EXTENDIBLE

Q12,250
1500013



Termómetro digital

Cajones
extraíbles

Mesa extendible



Gas



SLATE RUST-RESISTANT 36"

CON MESA EXTENDIBLE Y 4 QUEMADORES

Q14,750

1500216



NEW

Termómetro digital

Espacio de almacenamiento

Mesa extendible



Gas



PREMIUM GRIDDLE COVER

COMPATIBLE CON SLATE 30"

Q1,250
3400119



PREMIUM GRIDDLE COVER

COMPATIBLE CON SLATE 36"

Q1,275
3400120





NEW

**TRAVELER PORTABLE
GRIDDLE 17"**

Q3,750

1500012

**TRAVELER PORTABLE
GRIDDLE 22"**

Q4,500

1500213



NEW



Gas



EXPANDABLE STAND FOR
TRAVELER PORTABLE GRIDDLE 17" & 22"

Q3,000

3400015

NEW





6778



BREAKFAST KIT GRIDDLE FT
Q375



6780



SPATULA GRIDDLE FT FLEXIBLE
Q200



6781



SCRAPER GRIDDLE FT
Q200



6782



weber
SQUEEZE BOTTLES
GRIDDLE FT
Q150



6783



weber
BASTING DOME GRIDDLE FT
Q500



6776



weber
TOOL SET GRIDDLE FT
STARTER SET
Q675



3400074



PORTABLE GRIDDLE TOOL SET

SOLD OUT



9349



GRIDDLE SEASONING WAX

Q275

NEW



3400061



SMASHED BURGER SET

Q750

NEW



3400073

NEW

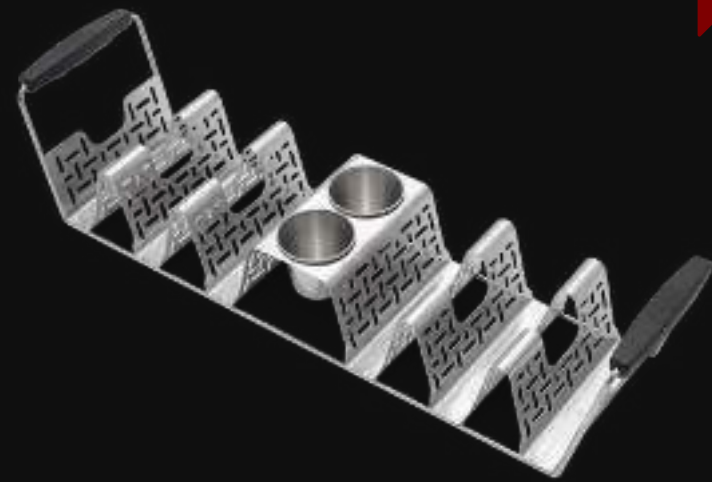

GRIDDLE TACO RACK

Q375



6777

NEW



GRIDDLE STARTER SET

Q500



6779

NEW



GRIDDLE SPATULA

Q275



3400105

NEW



WEBER WORKS - CONDIMENT CADDY

Q300



3400104

NEW



WEBER WORKS - BOTTLE HOLDER

Q150



3400106

NEW



WEBER WORKS - ORGANIZER KIT

Q600



6784

NEW



GRIDDLE KEEP WARM RACK

Q375



6785

NEW



GRIDDLE PRESS

Q400



6483



BURGER PRESS

Permite realizar tortas de 1/2 y 1/4 de lb.

Q175



3400024



NEW

weber | GRIDDLE CLEANING STONE

3 unidades

Q175



3400016



NEW

weber | TERMÓMETRO INFRAROJO

Q775



3400022

NEW



GRIDDLE CLEANING KIT 6PC

Q425

3400021

NEW



GRIDDLE CLEANING KIT 8PC

Q550

3400023



GRIDDLE SCOUR PAD REPLACEMENT 6PK

Q275



SPIRIT™



weber

SPIRIT E310

SOLD OUT

45010001



weber

SPIRIT E210

Q6,800

44010001



Gas



Gas



SPIRIT SP 335
Q13,000

46802101

3 QUEMADORES
1 QUEMADOR DESIGNADO PARA SELLAR EL CORTE
HORNILLA LATERAL
MUEBLE CERRADO PARA GUARDAR EL CILINDRO DE GAS
ACERO INOXIDABLE





Gas



NEW



SPIRIT™ E-310
Q9,500
46510001

3 QUEMADORES

ACABADO ESMALTADO EN PORCELANA PARA EVITAR LA OXIDACIÓN.
SEIS GANCHOS PARA HERRAMIENTAS PARA FACILITAR LA ACCESIBILIDAD.
SISTEMA DE GESTIÓN DE GRASA DE BAJO MANTENIMIENTO Y FÁCIL DE LIMPIAR.





Gas



NEW



SPIRIT™ E-330

Q11,250

46810001

3 QUEMADORES

1 QUEMADOR DESIGNADO PARA SELLAR EL CORTE

COCINE A FUEGO LENTO O SALTEE LAS VERDURAS EN EL QUEMADOR LATERAL.

REJILLAS DE HIERRO FUNDIDO DE PORCELANA Y ESMALTADO DURADERAS Y

FÁCILES DE LIMPIAR.



¡Convierte tu churrasquera Spirit II En plancha!



GRIDDLE SPIRIT II
3 QUEMADORES

SOLD OUT

6787



**COVER
PREM**

**GRILL *SPIRIT*[™]
Q1,000**

*VIENE CON EL ÍCONO BORDADO DE
FÁBRICA

7139





GENESIS



GENESIS

¿QUÉ INCLUYE?

- Nuevas mesas laterales Extra Grandes
- Nueva Zona de sellado Extra Grande
- Rejilla de cocción superior extensible
- Quemadores **PureBlu** de alto rendimiento
- WEBER CRAFTED Rejillas de cocción de acero inoxidable de 7 mm de diámetro o Parrillas de cocción de hierro fundido esmaltado en porcelana
- Nuevo marco Weber Crafted
- Quemador lateral
- Casillero lateral extra grande



weber
GENESIS E-335
Q15,750
3 Quemadores
1500535

weber
GENESIS E-435
Q20,000
4 Quemadores
36410001



Gas

» Conoce más



weber
GENESIS S-335
Q17,500
3 Quemadores
Acero Inoxidable
1500537

weber
GENESIS S-435
SOLD OUT
4 Quemadores
Acero Inoxidable
36400001



Gas

» Conoce más



CASILLERO EXTRA GRANDE

Creado para
almacenar todos los
accesorios del sistema
Weber Crafted



ESTACIÓN DE SELLADO

Área de calor intensa y
uniforme, para crear esas
perfectas marcas de parrilla
en tus cortes.

Sear Zone o Estación de
sellado se calienta mucho
más rápido que el resto de
las demás partes de la
parrilla.



COLGADOR PARA PARRILLA

Cuando estés
utilizando el sistema
de Weber Crafted
puedes colgar tu
parrilla al lateral de
tu Genesis.



PARRILLA EXPANSIBLE

¡Ahora puedes usar la
parrilla inferior para crear
un segundo nivel de
cocción!

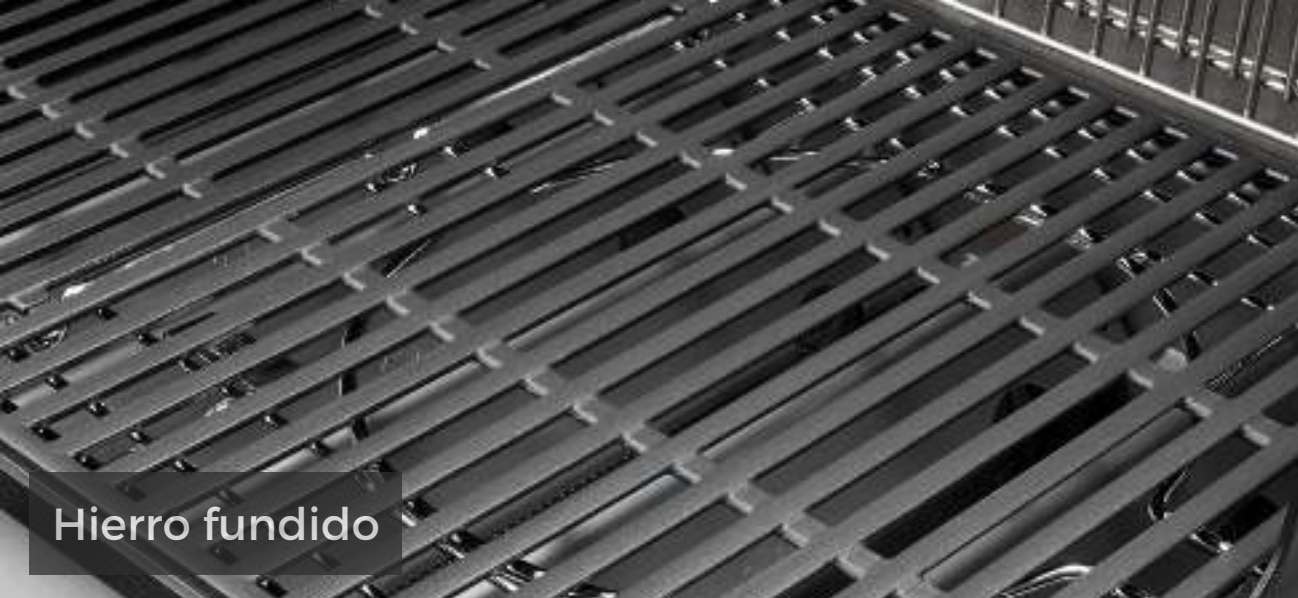

Hierro fundido



Acero Inox.



Las nuevas parrillas de las churrasqueras Genesis traen el sistema Gourmet que te permite retirar la parrilla y empotrar diferentes accesorios para expandir tus recetas.

NUEVO SISTEMA DE LIMPIEZA

Ahora la limpieza es mucho más fácil. Puedes extraer totalmente ambas bandejas atrapa grasa.

NUEVO MESAS LATERALES

Las nuevas Genesis ahora tienen mesas laterales mucho más grandes para que puedas colocar lo que necesites para facilitar tus asados.

jungla

NUEVA GENERACIÓN
GENESIS





Gas



GENESIS E-325

SOLD OUT

1500533



weber
GENESIS E-315
Q12,250
1500010



weber
GENESIS E-415
Q16,750
1500367



Gas

jungla

weber GENESIS ACERO ENAMELADO
SERIE E



E-315
Q12,250

E-415
Q16,750

E-325
Q13,000

E-335
Q15,750

E-435
Q20,000

SISTEMA WEBER CRAFTED				✓	✓
CANTIDAD DE QUEMADORES	3	4	3	3	4
SEAR STATION			✓	✓	✓
HORNILLA LATERAL				✓	✓
ENCENDIDO INFINITY	✓	✓	✓	✓	✓
PUERTA LATERAL PARA ACCESORIOS DE SISTEMA WEBER				✓	✓
PARRILLAS DE HIERRO FUNDIDO	✓	✓	✓	✓	✓



**GENESIS ACERO INOXIDABLE
SERIE S**



S-335
Q17,500



S-415
Q18,250

SISTEMA WEBER CRAFTED	✓	
CANTIDAD DE QUEMADORES	3	4
SEAR STATION	✓	
HORNILLA LATERAL	✓	
ENCENDIDO INFINITY	✓	✓
PUERTA LATERAL PARA ACCESORIOS DE SISTEMA WEBER	✓	
PARRILLAS DE ACERO INOXIDABLE	✓	✓

✓	
3	4
✓	
✓	
✓	✓
✓	
✓	✓



CESTA DE VEGETALES

Perfecta para asar vegetales, frutas, nueces, mariscos delicados y trozos de carne más pequeños.

Q1,250

Medidas 17.2 x 16.3"

7673



PLANCHA

Ideal para fajitas, desayunos y muchas otras recetas a la plancha.

SOLD OUT

Medidas 15.8 x 16.3"

7672



PARRILLA SELLADORA

La favorita para dejar el sellado de restaurante en tus cortes favoritos.

Q1,500

Medidas 16 x 16.3"

7670



PIEDRA PARA HORNEAR

Piedra con acabado antiadherente que ayuda a evitar que los alimentos se peguen. Cocina pizzas, pan y galletas sin problema!

Q1,250

Medidas 16 x 16.3"

7671



Crea comida que nunca hubieras pensado posible en tu parrilla, con la colección de cocina al aire libre WEBER CRAFTED. Haga arroz salteado y frito en el wok o use la cesta de vapor para cocer al vapor verduras y albóndigas

WEBER CRAFTED WOK & STEAMER

Q2,000

7606

**COMPATIBLE CON GENESIS Y SPIRIT 2016+ GAS GRILLS
Y SMOKEFIRE EX4 WOOD PELLET GRILLS

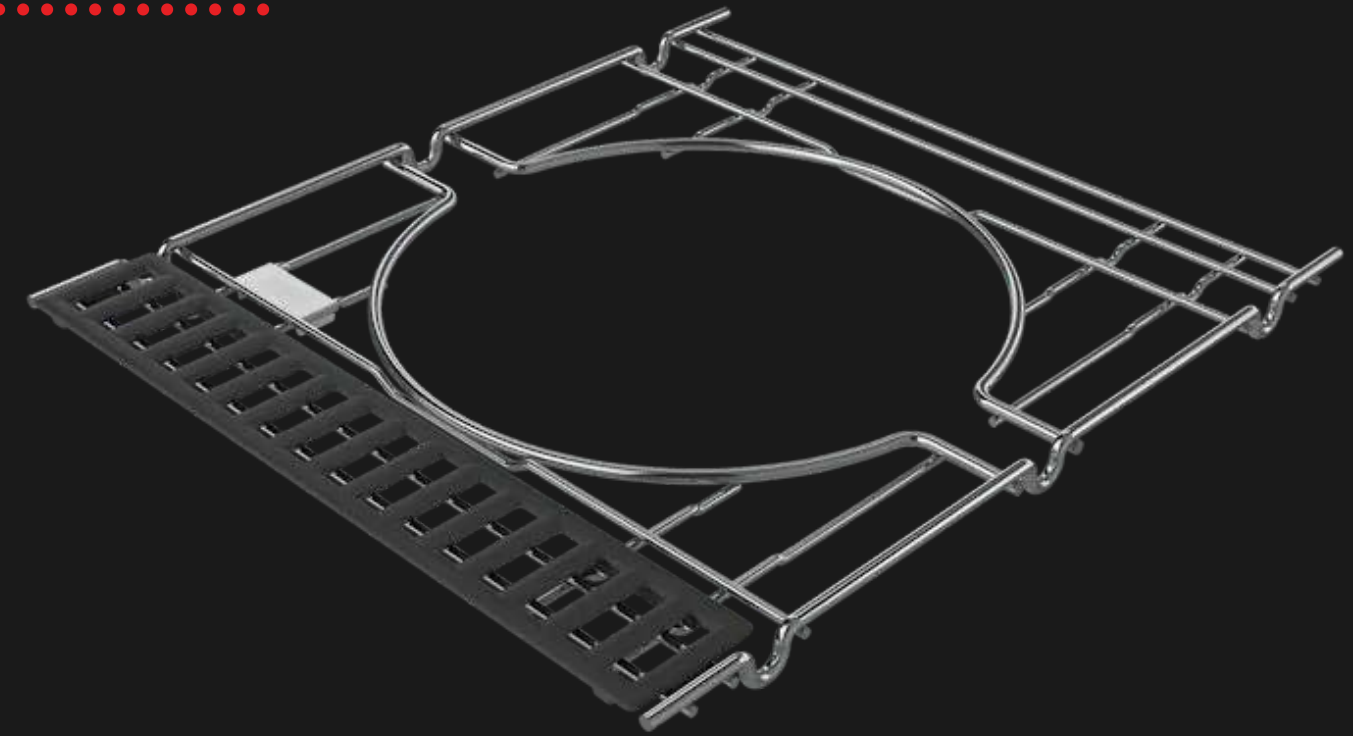

Simplemente reemplace su rejilla de cocción del lado derecho con el marco WEBER CRAFTED para desbloquear nuevas posibilidades de asar a la parrilla.

**WEBER CRAFTED FRAME KIT -
GENESIS**

Q600

7677

****COMPATIBLE CON GENESIS
E-325S/EX-325S/S-325S/SX-325**

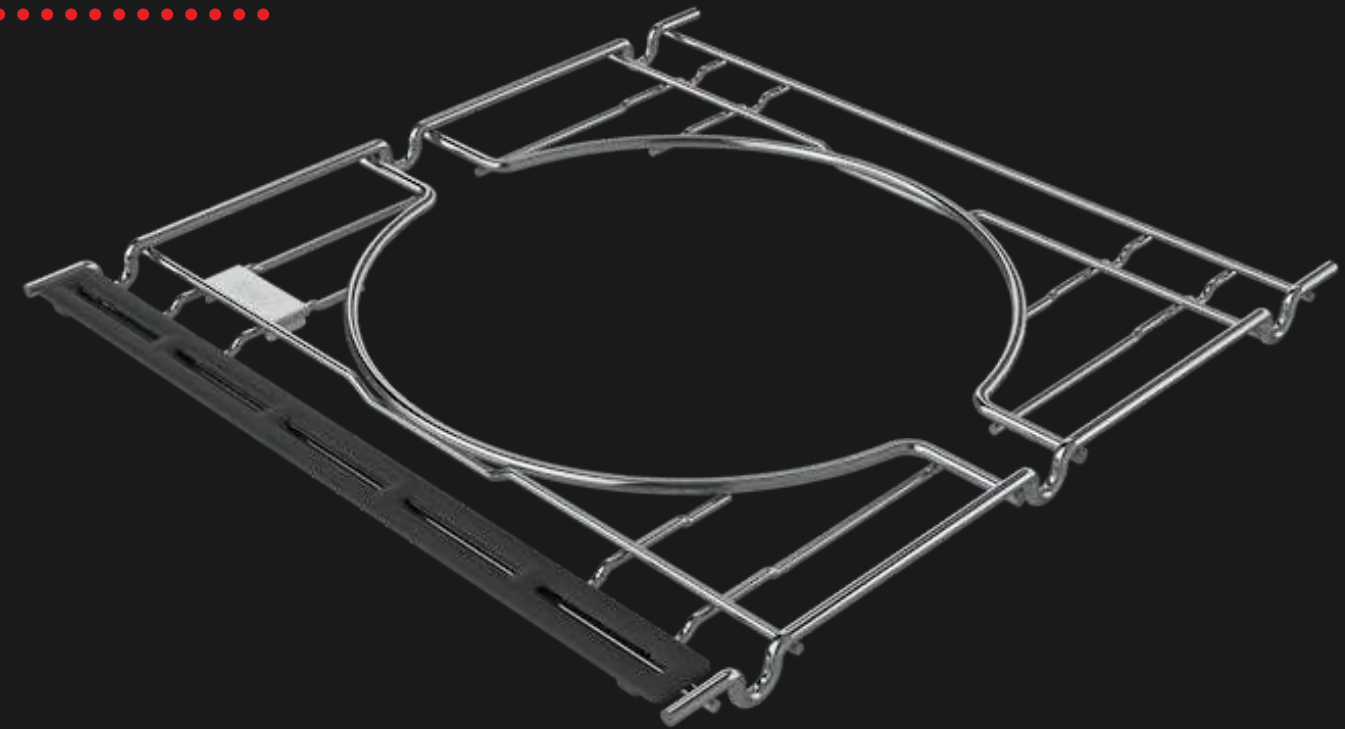

Simplemente reemplace su rejilla de cocción del lado derecho con el marco WEBER CRAFTED para desbloquear nuevas posibilidades de asar a la parrilla.

**WEBER CRAFTED FRAME KIT
SPIRIT - SEARWOOD - SMOKEFIRE**

Q600

7678

****COMPATIBLE CON SPIRIT 2016+ GAS GRILLS, SEARWOOD 600/XL 600
PELLET GRILLS, Y SMOKEFIRE EX4/EX6 WOOD PELLET GRILLS**



**COVER GRILL
PREM**

**GENESIS
Q1,000**

*VIENE CON EL ÍCONO BORDADO DE FÁBRICA
*COMPATIBLE CON GENESIS DE 3 QUEMADORES

7757





Griddle Genesis II

4 quemadores

Q3,750.00

6789



Griddle Genesis II

3 quemadores

SOLD OUT

6788



6416

x10



**Large Drip Pans
Q125**

Perfectos para ahumar
o recibir grasa y jugos del corte



6498

x10



**Bandeja Larga
Q150**

Perfecta para colocarle chips
para ahumar o vegetales



6415

x10



**Bandeja pequeña
Q100**

Para sistema de limpieza
o asar vegetales



weber | **Luz Grill & Go**

La luz Grill and Go es una luz multifuncional que se encaja fácilmente a la manilla de tu asador y se puede sacar para tener una luz extra donde lo necesites.

Su sensor de movimiento le permite mantenerse encendida cuando la tapa está abierta y apagarse cuando se cierra la tapa y así ahorrar batería.

COMPATIBLE CON GENESIS II Y SPIRIT II

Q375

7661

CHURRASQUERAS
EMPOTRABLES

jungla



Gas

Q20,000
69009/8



Steer | Gas Grill
24"

CONFIRMAR
STOCK

Q30,000
47628



Angus | Gas Grill
30"

CONFIRMAR
STOCK

Q45,000
57568



Brahma | Gas Grill
38"

BAJO PEDIDO

PUEDES COMPRAR BAJO PEDIDO | PIDE EL CATÁLOGO DE EQUIPOS EMPOTRABLES



Gas

Q50,000
62648

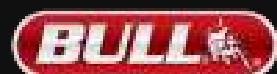

Diablo | Gas Grill
46"

CONTRA PEDIDO



CARBÓN

Q25,000
88787



Bison | Carbón
30"

CONFIRMAR STOCK

PUEDES COMPRAR BAJO PEDIDO | PIDE EL CATÁLOGO DE EQUIPOS EMPOTRABLES



Gas



| **SUMMIT SB38**

- 5 Quemadores Principales
- Perilla extra para sellar carne.
- Termómetro integrado a la tapa.
- Diseño con mueble abierto
- Acero Inoxidable
- Rosticero Eléctrico
- Luces automáticas
- Luces en perillas
- Caja de acero inoxidable para ahumar
- Grill para empotrar
- Mueble inferior adherido a la parrilla

CONSULTA POR MAYOR INFORMACIÓN
BAJO PEDIDO



jungla



ACCESORIOS



7416



Chimenea iniciadora
de carbón compacta

Q225



Chimenea iniciadora
de carbón

Q300



7447



7649



Charcoal Rake

Q225



17302



x2



Tablas de cedro para
ahumar

Q100



KJCHAR



**LUMP CHARCOAL
XL KAMADO
Q500**



17952



Briquetas - 20 lbs

SOLD OUT



7417



x24



**Cubos de encendido
Q75**



7652

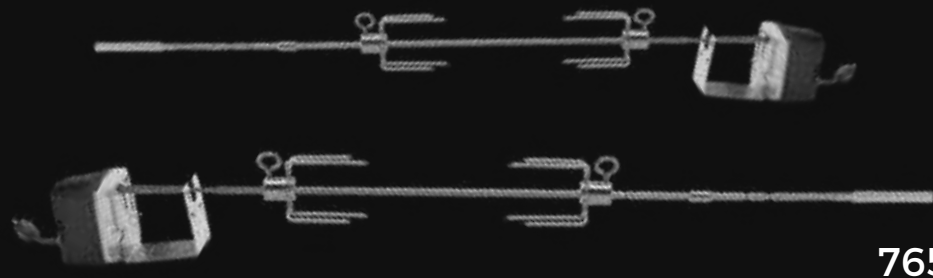

7653



**Rosticero Eléctrico
Genesis II Grill 2 y 3 Quemadores**

SOLD OUT

**Genesis II Grill 4 y 6 Quemadores
Q2,000**



2290

*No compatible
con Ahumadores
Weber



**Rosticero Eléctrico 22"
Q3,000**



7659



**Rosticero Eléctrico
Spirit II Grill 2 y 3 Quemadores
Q1,500**



7403

NEW



CHAR-BASKETS

Q275



7675

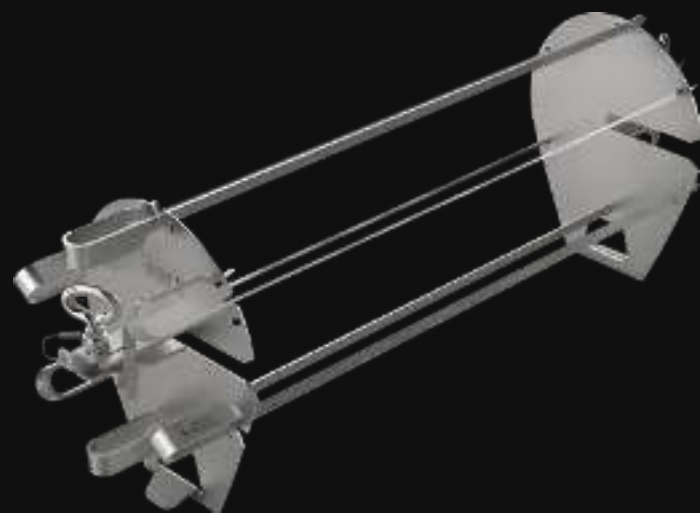

Rotisserie Skewer Set

Q825



7576



Smoker Box

Q375



6532



**BBQ MITT
Q150**

7017



SMOKING GLOVES

Q325

- Talla L de EE. UU., talla 9 de la UE
- Resistente al calor hasta 204 °C/400 °F



6535



Premium Gloves

Q500

- Talla L de EE. UU., talla 9 de la UE
- Resistente al calor hasta 250 °C/482 °F





6768



PRECISION TONGS

Q250



6625



PRECISION SET - TONGS & SPATULA

SOLD OUT



6772



PRECISION 3 PC GRILL TOOL SET

Q500



6620



STANDARD SPATULA

Q150



6771



**PRECISION SET
TONGS & SPATULA GRILLING**

Q425



6770



SPATULA WIDE - PRECISION

Q300



7008



weber
Butcher Paper
Q600



7032



weber
Cut & Catch Cutting Board
Q400



7005



weber
Cutting Board
Q450



6471

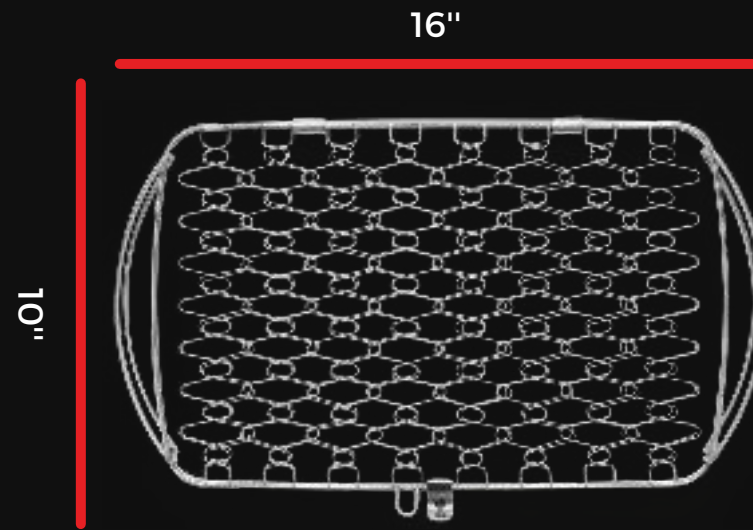

Fish Basket - Large
Q500



7647

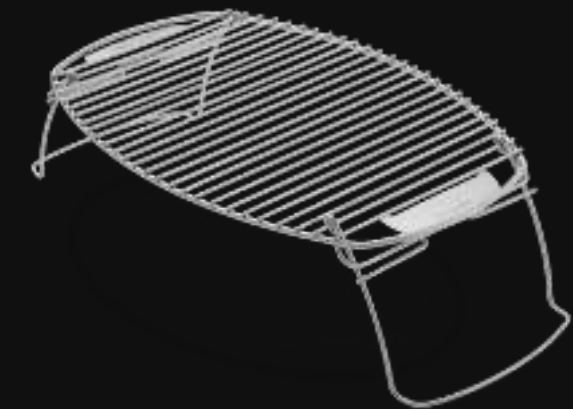

Grilling Rack
Q525



6470

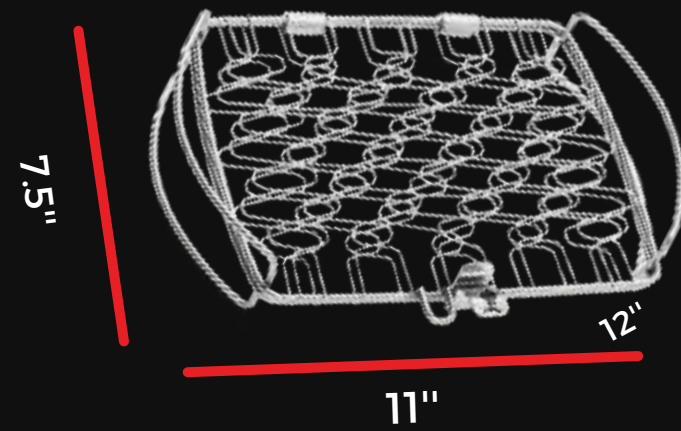

Fish Basket - Small
Q350



6481



Cesta Pequeña
Q200

6677



Cesta Mediana

SOLD OUT

6434



Cesta grande
Q375

6482



Soporte para pollo
Q300

6605



Para medio costillar
Q275

6469



Costillar grande
para costillas y culotte
Q300



GRILLIGHT-004



GRILLIGHT

Garras de oso

Utilízalas para deshebrar la carne o para movilizar cortes pesados de un lado a otro.

Q190



**50%
OFF**

BANCO-023



GRILLIGHT

Set de herramientas con luz 2 Piezas

Q450

GRILLIGHT-002



BBQ-AID
BUILT TO LAST™

Set de utensilios

- Cucharón
- Cuchara grande
- Cucharón para pasta
- Machacador
- Espátula
- Batidor de globo
- Soporte para utensilios

Q300

Normal Q600





6691



**Paleta para pizza - Se dobla
Q450**



6320



**Skewer Grilling Set
Q150**



KJ-PP



**Paleta para pizza
Q250**

*EN INGLÉS

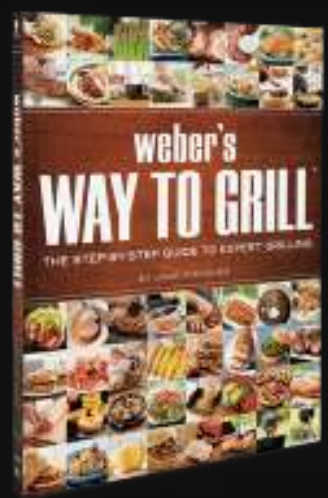
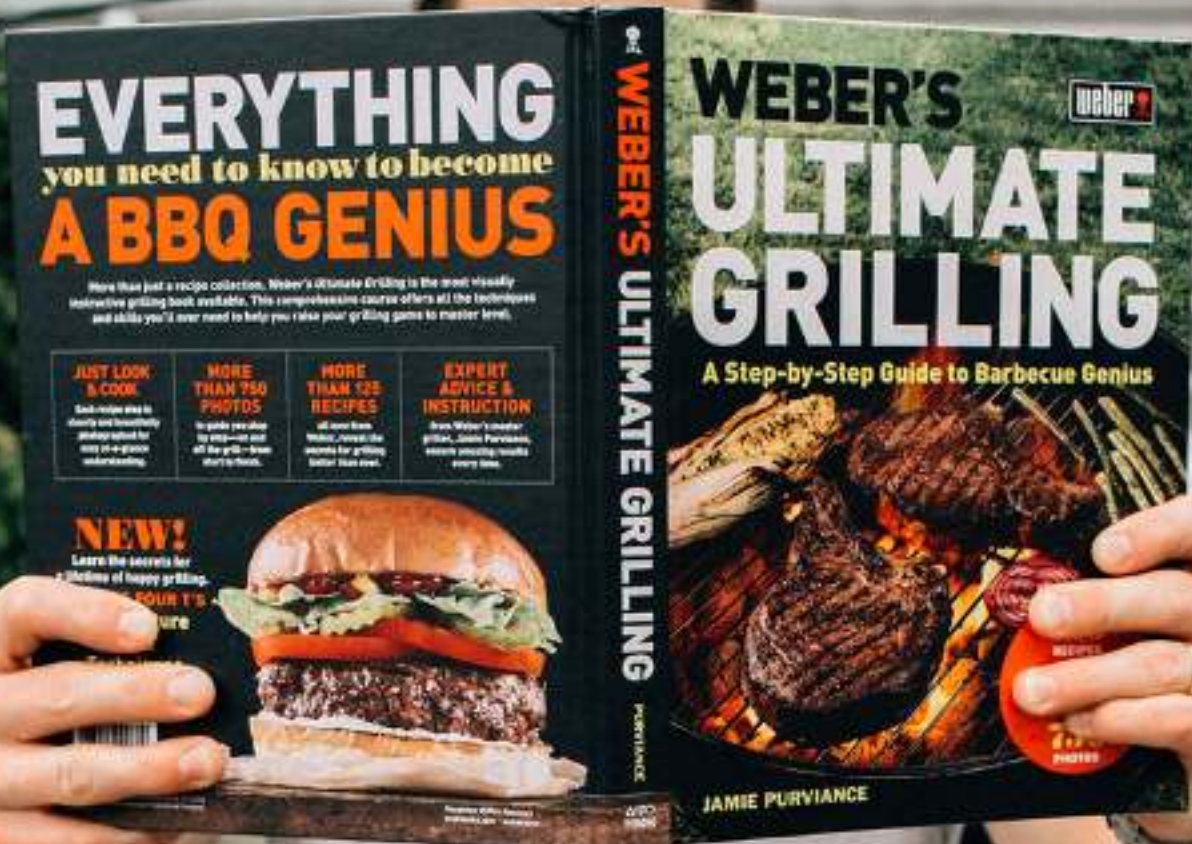

Q300
9551

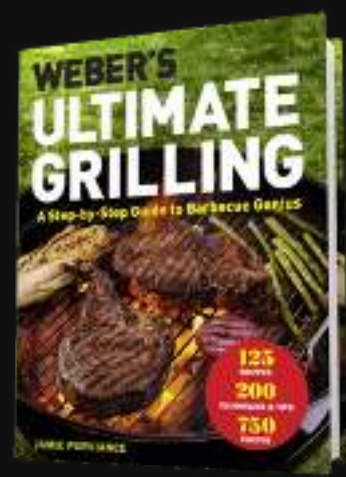

SOLD OUT
9558

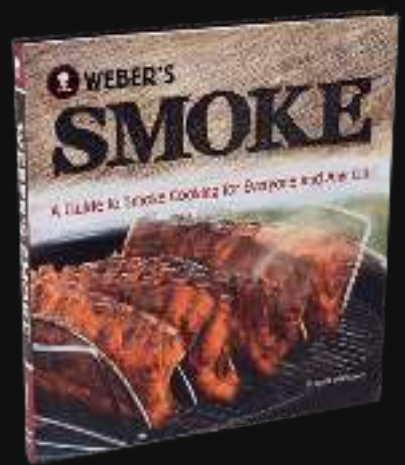

Q300
7605



Q300
9552



Q325
9553



SOLD OUT
9554

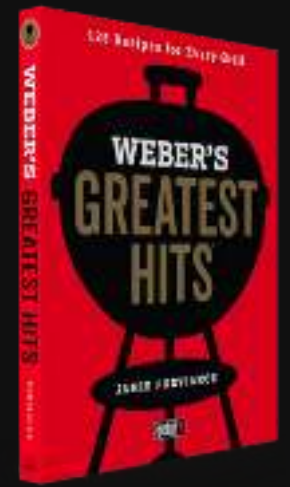

Q300
9557



6277



12"



Cleaning Brush
Q175



7401



Grill & Tool Holder
Q50



6278



18"



Cleaning Brush
Q200





**Limpiador
desengrasante
en espuma**



**Limpieza interna
Q55**



**Pulidor exterior de acero
en spray**



**Limpieza externa
Q100**

8036

**Fibra esponja de alto
desempeño para parrillas**



Limpieza interna

SOLD OUT





6750



**Instant Read
Q200**

7202



**iGrill Mini
Q850**

7203



**iGrill 2
Q1,500**

7204



**iGrill 3
Q1,500**

Termómetro smart empotrable a
SPIRIT II y GENESIS II.

3201



**Weber Connect
Q1,750**

Asistente inteligente
paso a paso

7212 - Sonda de temperatura extra +Q200

weber | **Bandeja para asar deluxe**

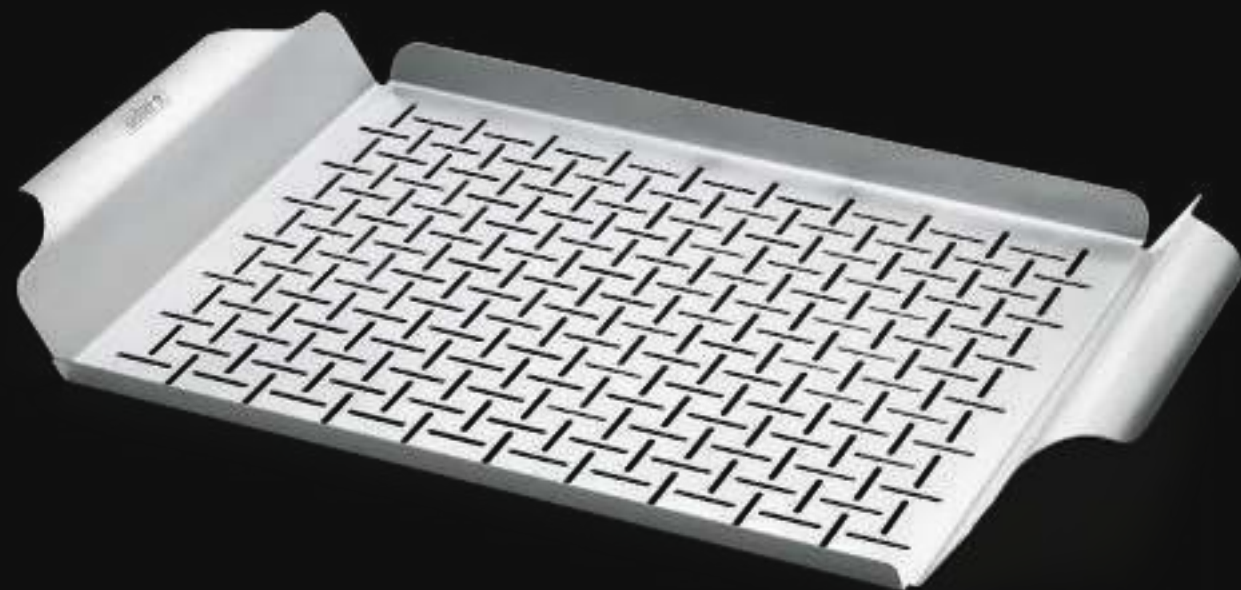

Saltea verduras mientras el filete adquiere color al lado. Usa la bandeja para asar Deluxe para aportar a cualquier plato ese inconfundible sabor a barbacoa.

Q400
6435





weber | Grill & Griddle

PARA GAS O CARBÓN

Sella

Plancha



Para parillas de 3 quemadores en adelante o para churrasqueras de carbón de 22" en adelante

Q1,000
8860



weber | Dutch Oven & Grill

2 EN 1 - PLANCHA Y HIERRO



La tapa puedes usarla como plancha

Hierro fundido porcelanizado con recubrimiento para facilitar limpieza

Q1,500
8859

weber | Premium Grilling Stone



18.2" Diámetro - Hierro fundido porcelanizado

Q800
8829





SOPORTE PARA POLLO CON INFUSOR DE LÍQUIDOS

Agrega cerveza,
vino o líquido de tu
preferencia para
saborizar el pollo
desde adentro



Q400
6731

GRILLIGHT | Grill Mat

CONVIERTE TU PARRILLA EN PLANCHA
SIN DEJARLA SUCIA

15"



Set Grill Mat Redondo y Cuadrado

Q250
GRILLIGHT-000





weber | **Gabacha Weber**
Q200

*viene con el ícono bordado de fábrica
6534 / 6533

GABACHA DE GABARDINA
BORDADO DE NOMBRE
+ Q150

DEMORA 2 DÍAS HÁBILES
CONSULTA PRECIOS PARA LOGO



- 7 bolsillos para acceder fácilmente a los elementos esenciales de la churrasquera
- Material duradero y repelente de líquidos que protege la ropa
- El diseño de espalda cruzada brinda un ajuste cómodo
- Talla única con longitud y cintura ajustables
- Puede lavarse a lavadora



| Gabacha Weber Q650

*viene con el ícono bordado de fábrica
6786

BORDADO DE NOMBRE
+ Q150

DEMORA 2 DÍAS HÁBILES
CONSULTA PRECIOS PARA LOGO